

深沟球轴承

Deep Groove Ball Bearing

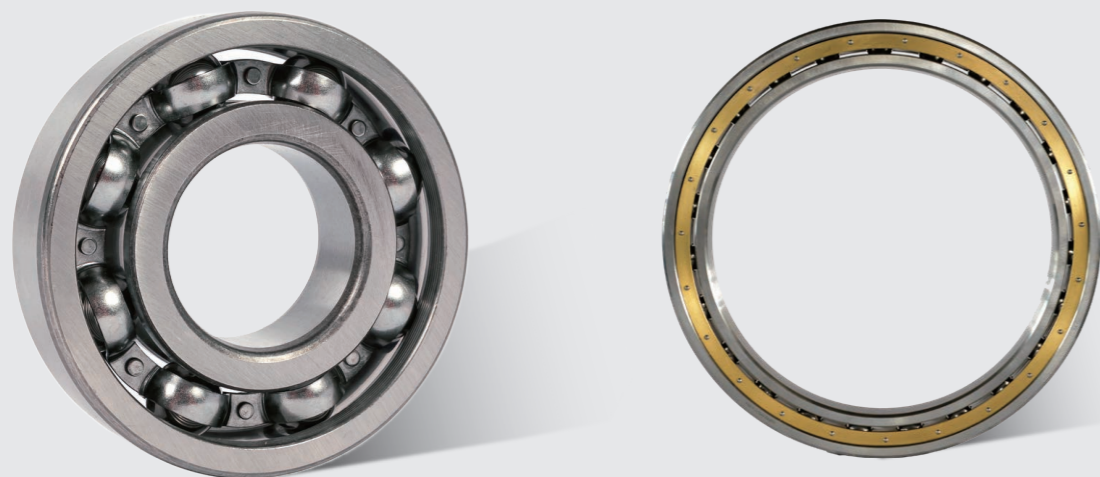

深沟球轴承是最常见的一种滚动轴承,其设计简单,具有低摩擦系数,因此非常适合高速运转。它们能够承受径向载荷和一定程度的轴向载荷,并且结构紧凑,适用于空间受限的应用。深沟球轴承的密封和防尘性能也使其在恶劣环境下表现良好,广泛应用于电动机、风扇、汽车及家用电器中。

Deep groove ball bearings are one of the most widely used types of rolling bearings due to their simple design and low friction, making them ideal for high-speed applications. They are capable of handling both radial and moderate axial loads, and their compact size is advantageous in space-constrained environments. With excellent sealing and dustproof properties, these bearings perform reliably even in harsh conditions. As a result, they are commonly employed in electric motors, fans, automobiles, and household appliances.

深沟球轴承

Deep groove ball bearing

带密封圈 With seals 带防尘盖 With shields

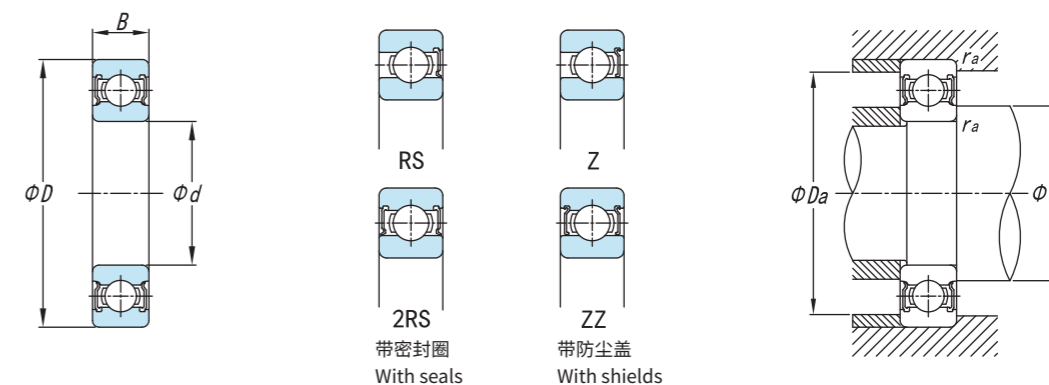

基本尺寸 Principal Dimensions (mm)				基本额定负荷 Basic Load Ratings (kN)		极限转速 Limit Speed (r/min)		现代号 New code	重量 Mass (kg)
d	D	B	r _{min}	C _r	C _{or}	Grease	Oil		
50	130	31	2.1	88	55	5300	6300	6410	1.85
	111	27	2.3	62	38	6300	7500	810	1.1
	110	27	2	62	38	6300	7500	6310	0.998
	110	27	2	62	36	6300	7500	6310M	0.998
	90	20	1.1	35	23.2	7100	8500	6210	0.504
	80	16	1	22	16.3	6500	10000	6010	0.248
55	140	33	2.1	95	62	5000	6000	6411	2.31
	120	29	2	71.5	45	5600	6700	6311M	1.31
	120	29	2	71.5	45	5600	6700	6311	1.39
	100	21	1.5	44.3	28.8	6300	7500	6211	0.605
60	150	35	2.1	107	70	4800	5600	6412	2.78
	130	31	2.1	82	50	5000	6000	6412	1.64
	130	31	2.1	82	50	5000	6000	6412M	2.07
	95	18	1.1	30	23	6700	8000	6012	0.426
65	90	13	1	19.9	17	6700	8000	61913	0.203
	100	18	1.1	32	25	6300	7500	6013M	0.553
	100	18	1.1	32	25	6300	7500	6013	0.428
	120	23	1.5	57	40	5300	6300	6213	0.973
	120	23	1.5	57	41	5300	6300	213M	1.01
	120	23	1.5	57	41	5300	6300	180213	1.06
	140	33	2.1	95	59.5	4800	5600	6313	2.10
	140	33	2.1	95	59.5	4800	5600	6313M	2.10
	160	37	2.1	118	78.5	4500	6300	6413	3.25
	70	110	20	1.1	38	31	6000	7000	6014
110		20	1.1	38	31	6000	7000	6014M	0.757

深沟球轴承

Deep groove ball bearing

带密封圈 With seals 带防尘盖 With shields

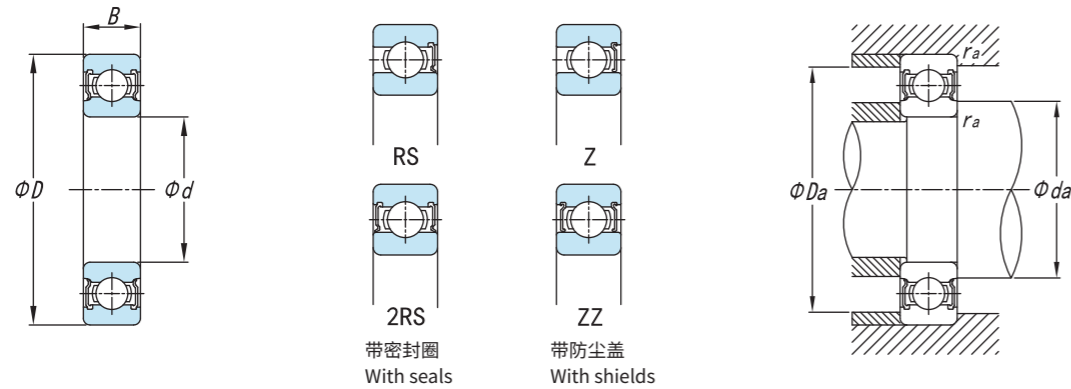

基本尺寸 Principal Dimensions (mm)				基本额定负荷 Basic Load Ratings (kN)		极限转速 Limit Speed (r/min)		现代号 New code	重量 Mass (kg)
d	D	B	r _{min}	C _r	C _{or}	Grease	Oil		
70	125	24	1.5	61.2	46	5000	6000	6214M	1.34
	150	35	2.1	107	68	4500	5300	6314M	2.55
	150	35	2.1	107	68	4500	5300	6314	2.46
	180	42	3	143	103	3800	4500	6414	4.73
72	110	20	1.1	38	31	4500	5300	60/72M	0.584
75	115	20	1.1	38	31	5600	6700	6015	0.63
	115	20	1.1	38	31	5600	6700	6015M	0.804
	115	13	0.6	29	26	5600	6700	16015	0.583
	130	25	1.5	66	50	4800	5600	6215	1.16
	130	25	1.5	66	50	4800	5600	6215M	1.45
	130	25	1.5	66	50	4800	5600	6215	1.16
	160	37	2.1	116	77	4300	5000	6315	3.10
	160	37	2.1	116	77	4300	5000	6315M	3.77
80	110	16	1	27.5	25	5600	6700	61916	0.350
	125	22	1.1	47	40	5300	6300	6116	0.86
	125	22	1.1	47	40	5300	6300	6116M	1.08
	140	26	1.5	71.5	54.5	4500	5300	6216	1.43
	170	39	2.1	125	86.5	4500	4800	6316	3.64
85	130	22	1.1	47.5	40	5000	6000	6017	0.935
	130	22	1.1	47.5	40	5000	6000	6017M	1.12
	150	28	2	84	65	4300	5000	6217	1.8
	150	28	2	84	65	4300	5000	6217M	1.91
	180	41	3	102	96.5	3800	4500	6317M	4.33

深沟球轴承

Deep groove ball bearing

带密封圈 With seals 带防尘盖 With shields

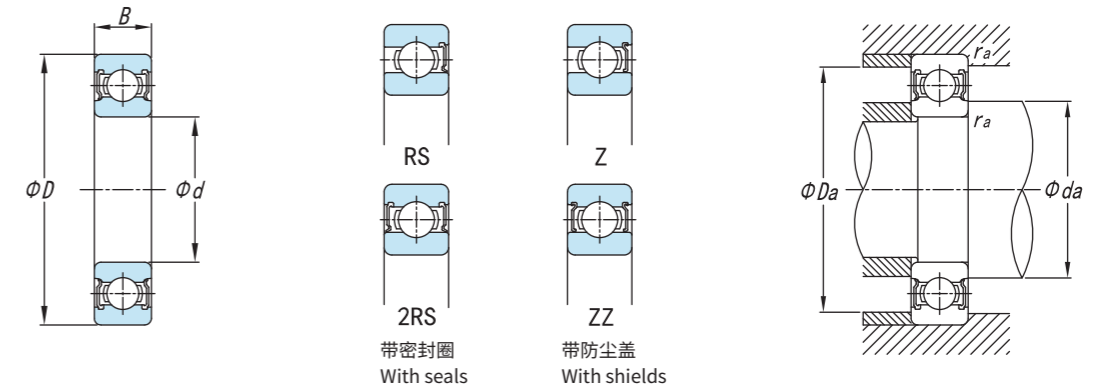

基本尺寸 Principal Dimensions (mm)				基本额定负荷 Basic Load Ratings (kN)		极限转速 Limit Speed (r/min)		现代号 New code	重量 Mass (kg)
d	D	B	r _{min}	C _r	C _{or}	Grease	Oil		
85	210	52	4	170	136	3200	3800	6417	8.12
90	125	18	1.1	33	31.5	5000	6000	61918	0.572
	125	18	1.1	33	31.5	5000	6000	61918M	0.68
	140	24	1.5	58.5	50	4800	5600	6018	1.16
	140	16	1	58.5	50	4800	5600	16018M	0.941
	140	24	1.5	58.5	50	4800	5600	6018M	1.39
	160	30	2	73.5	72	3800	4500	6218	2.19
	190	43	3	144	108	3400	4000	6318	4.97
95	120	13	1.5	19.9	22.8	5000	6700	1000819	0.307
	145	16	1	40.5	39	4500	5300	16019	0.884
	145	24	1.5	78.5	54	4500	5300	6019	1.14
	170	32	2.1	110	81.5	3600	4300	6219	2.61
	170	32	2.1	110	81.5	3600	4300	6219M	3.26
	200	45	3	152	122	3200	3800	6319	5.65
	240	55	4	204	171	3400	3600	6419M	13.4
100	150	24	1.5	62.5	56.5	4300	5000	6020	1.17
	150	24	1.5	62.5	56.5	4300	5000	6020M	1.4
	180	28	1.8	116	92	3400	4000	720	2.7
	180	34	2.1	122	93	3400	4000	6220	3.2
	215	47	3	171	141	2800	3600	6320	7.01
	215	47	3	171	141	2800	3600	6320M	7.11
	250	58	4	224	195	2600	3400	6420	12.8
	250	58	4	224	195	2600	3400	6420M	15.4

深沟球轴承

Deep groove ball bearing

开放型 Open type

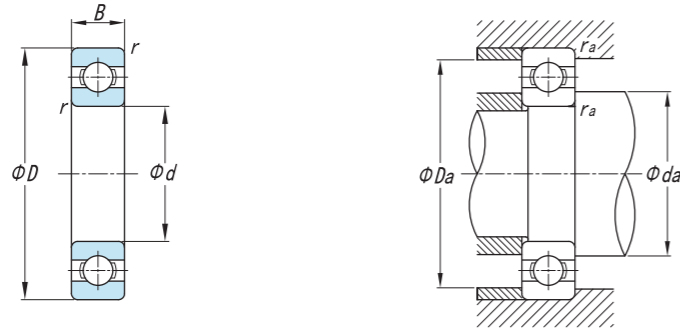

基本尺寸 Principal Dimensions (mm)				基本额定负荷 Basic Load Ratings (kN)		极限转速 Limit Speed (r/min)		现代号 New code	重量 Mass (kg)
d	D	B	r _{min}	C _r	C _{or}	Grease	Oil		
100	150	24	1.5	62.5	56.5	4300	5000	6020	1.17
	150	24	1.5	62.5	56.5	4300	5000	6020M	1.4
	180	28	1.8	116	92	3400	4000	720	2.7
	180	34	2.1	122	93	3400	4000	6220	3.2
	215	47	3	171	141	2800	3600	6320	7.01
	215	47	3	171	141	2800	3600	6320M	7.11
	250	58	4	224	195	2600	3400	6420	12.8
	250	58	4	224	195	2600	3400	6420M	15.4
105	160	26	2	72.8	65.5	4000	4800	6021	1.62
	160	26	2	72.8	65.5	4000	4800	6021M	1.92
	180	22	1.1	68	65	4200	5000	721	2.61
	190	36	2.1	133	105	3200	3800	6221	3.66
	225	49	3	240	153	2800	3400	6321M	7.84
110	140	16	1	24.8	28	4300	5000	61822M	0.505
	150	20	1.1	43.5	44.5	4000	4800	61922M	0.888
	170	19	1	57.2	57	3800	4500	16022	1.48
	170	28	2	82	73.5	3800	4500	6022	2.09
	170	28	2	82	73.5	3800	4500	6022M	2.72
	200	38	2.1	145	106	2800	3400	6222	4.29
	200	38	2.1	145	106	2800	3400	6222M	5.46
	240	50	3	195	176	2400	3000	6322M	9.49
	280	65	4	247	226	2200	3000	6422	18.3
	280	65	4	247	226	2200	3000	6422M	19
120	150	16	1	24.5	28	3800	4500	61824M	0.568
	165	22	1.1	53	54	3600	4300	61924M	1.54
	180	19	1	60.5	64	3400	4000	16024	1.64

深沟球轴承

Deep groove ball bearing

开放型 Open type

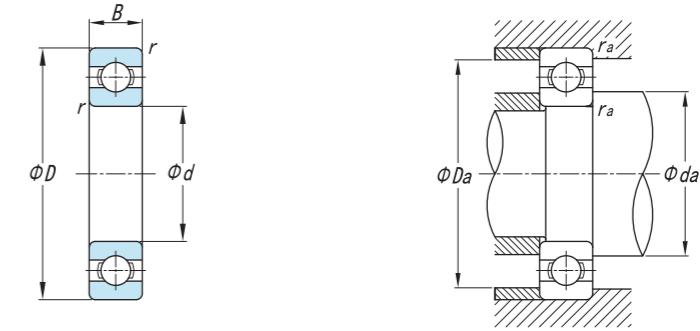

基本尺寸 Principal Dimensions (mm)				基本额定负荷 Basic Load Ratings (kN)		极限转速 Limit Speed (r/min)		现代号 New code	重量 Mass (kg)	
d	D	B	r _{min}	C _r	C _{or}	Grease	Oil			
120	180	19	1	60.5	64	3400	4000	16024M	1.82	
	180	28	2	85.2	80	3400	4000	6024	2.21	
	180	28	2	85.2	80	3400	4000	6024M	2.68	
	215	40	2.1	154	131	2800	3400	6224	5.26	
	215	40	2.1	154	131	2800	3400	6224M	6.33	
	260	55	3	217	196	2200	2800	6324	12.2	
	260	55	3	217	196	2200	2800	6324M	13.3	
127	228.6	34.925	2	148	133	2200	2800	925	7	
130	180	24	1.5	65	67	3400	4000	61926M	1.92	
	180	24	1.5	65	67	3400	4000	61926	1.56	
	190	19	0.7	56	60	3200	3800	726	1.7	
	190	19	0.7	56	60	3200	3800	726M	1.91	
	200	22	1.1	79.5	81.5	3200	3800	16026M	2.32	
	200	22	1.1	79.5	81.5	3200	3800	16026	2.19	
	200	33	2	109	94	3200	3800	6026	3.29	
	200	33	2	109	94	3200	3800	6026M	3.96	
	230	40	3	153	134	2600	3200	6226	6.04	
	280	58	4	251	239	2200	2600	6326	14.7	
	280	58	4	251	241	2200	2600	6326M	18.3	
	140	175	18	4	251	241	2200	2600	61828M	18.3
		190	24	1.1	37	40	3400	4000	61928M	0.93
210		33	2	106	102	3000	3600	6028	3.25	
210		33	2	106	102	3000	3600	6028M	3.89	
250		42	3	166	150	2400	3000	6228	7.41	
250		42	3	166	150	2400	3000	6228M	9.44	
300		62	4	253	246	2000	2600	6328	18.5	
300		62	4	253	246	2000	2600	6328M	21.3	
300		62	4	253	246	2000	2600	6328M	21.3	

深沟球轴承

Deep groove ball bearing

带凸缘 With flange

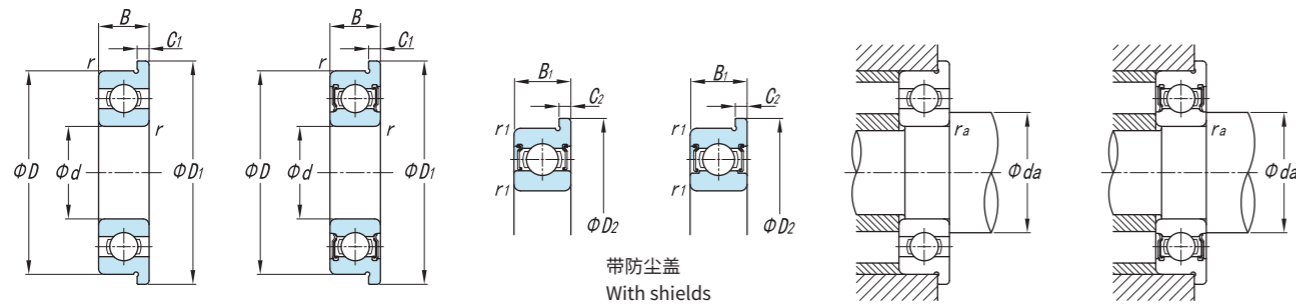

带防尘盖
With shields

基本尺寸 Principal Dimensions (mm)				基本额定负荷 Basic Load Ratings (kN)		极限转速 Limit Speed (r/min)		现代号 New code	重量 Mass (kg)
d	D	B	r _{min}	C _r	C _{or}	Grease	Oil		
144	185	22	0.7	62.5	67	3600	4000	928	1.07
149	201	33	0.7	105	102	3000	3600	930	1.79
150	190	20	1.1	43.7	51.4	2800	3600	61830M	1.42
	210	28	2	84.5	90	2800	3400	61930M	2.56
	225	24	1.1	89	98.5	2600	3200	16030M	3.63
	225	35	2.1	123	117	2600	3200	6030	4.14
	225	35	2.1	123	117	2600	3200	6030M	5.01
	270	45	3	176	169	2000	2600	6230	9.76
	270	45	3	176	169	2000	2600	6230M	11.8
	320	65	4	360	280	1800	2200	6330	21.4
320	65	4	360	280	1800	2200	6330M	26	
160	200	20	1.1	49.5	59	2800	3400	61832M	1.45
	200	20	1.1	49.5	59	2800	3400	61832	1.22
	220	28	2	89	90	2600	3200	61932M	2.82
	240	25	1.5	94	104	2400	3000	10632M	4.61
	240	38	2.1	143	135	2400	3000	6032	5.63
	240	38	2.1	143	135	2400	3000	6032M	6.41
	290	48	3	200	201	1900	2400	6232	12.3
	290	48	3	200	201	1900	2400	6232M	14.4
340	68	4	238	327	1800	2200	6332M	31.3	
165	250.5	35	2.5	147	143	2200	2600	733	6.44
170	215	22	1.1	65	61	2600	3200	61834M	1.87
	230	28	2	115	100	2400	3000	61934M	5.19
	260	28	1.5	119	129	2200	2800	16034M	5.83

深沟球轴承

Deep groove ball bearing

带凸缘 With flange

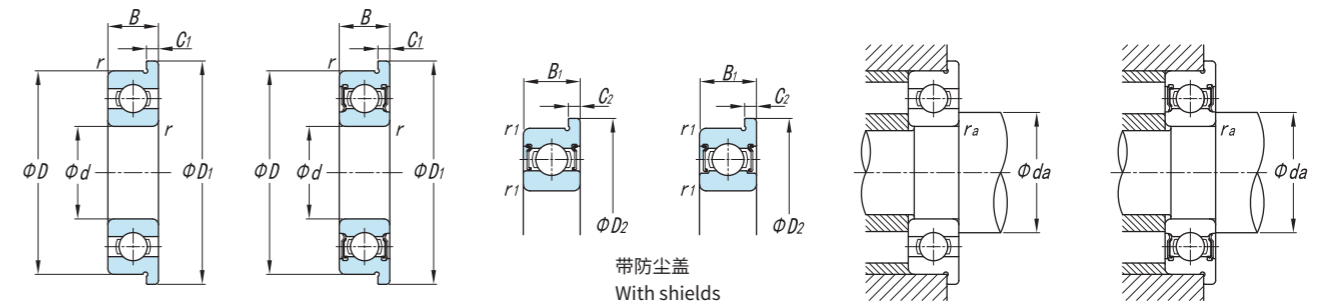

带防尘盖
With shields

基本尺寸 Principal Dimensions (mm)				基本额定负荷 Basic Load Ratings (kN)		极限转速 Limit Speed (r/min)		现代号 New code	重量 Mass (kg)	
d	D	B	r _{min}	C _r	C _{or}	Grease	Oil			
170	260	42	2.1	161	166	2200	2800	6034M	8.23	
	260	42	2.1	161	166	2200	2800	6034	6.78	
	310	52	4	225	240	1900	2400	6234	15.2	
	310	52	4	225	240	1900	2400	6234M	18.4	
	360	72	4	350	380	1700	2000	6334	30.9	
	360	72	4	350	380	1700	2000	6334M	34.9	
180	225	22	1.1	60	80	2400	3000	61836	2.1	
	250	33	2	118	137	2200	2800	61936M	5.27	
	259.5	52	2	140	137	2200	2800	63936X1M	8.87	
	280	46	2.1	186	196	2200	2600	6036	8.83	
	280	46	2.1	186	196	2200	2600	6036M	10.7	
	280	31	2.1	130	146	2000	2600	16036	10.3	
	320	52	4	240	260	1800	2200	6236	15.4	
	320	52	4	240	260	1800	2200	6236M	17.8	
	190	240	24	1.5	73	94	2200	2800	61838M	2.38
		260	33	2	105	120	2200	2800	1000938K	5.2
260		33	2	105	120	2200	2800	1000938K	5.85	
269.5		33	2	127	138	2200	2800	61938X1M	6.87	
290		31	2	145	155	2000	2600	16038M	8.11	
290		46	2.1	191	211	2000	2600	6038M	11.1	
290		46	2.1	191	211	2000	2600	6038	9.58	
340		55	4	265	305	1700	2000	6238	18.9	
340		55	4	265	305	1700	2000	6238M	23.2	
200		250	24	1.5	96	119	2200	2800	61840M	2.89
	280	38	2.1	135	150	2000	2600	61940	6.95	
	310	34	2	162	179	1900	2400	16040M	10.3	

深沟球轴承

Deep groove ball bearing

带止动槽 With snap ring groove

带止动环 With snap ring

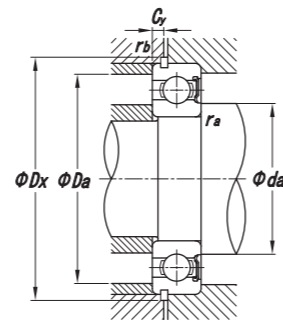
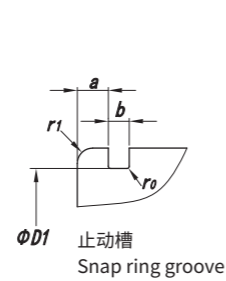
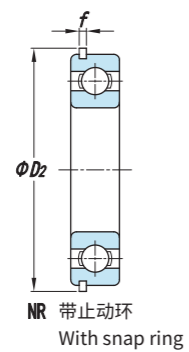
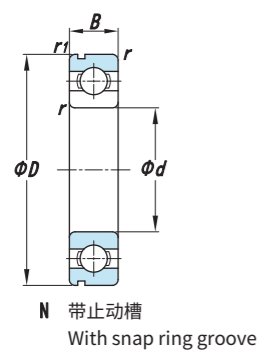

基本尺寸 Principal Dimensions (mm)				基本额定负荷 Basic Load Ratings (kN)		极限转速 Limit Speed (r/min)		现代号 New code	重量 Mass (kg)
d	D	B	r _{min}	C _r	C _{or}	Grease	Oil		
200	310	51	2.1	213	245	1900	2400	6040M	14.3
	310	51	2.1	213	245	1900	2400	6040	11.7
	360	58	4	285	332	1700	2000	6240	22.6
	360	58	4	260	305	1700	2000	6240M	24.4
	420	80	5	380	460	1400	1800	6340M	57.4
220	270	24	1.5	70	100	1900	2400	61844M	2.82
	300	38	2.1	148	162	1900	2400	61944M	9.3
	340	37	2.1	170	215	1800	2200	16044M	11.5
	340	56	3	245	293	1800	2200	6044	15.6
	340	56	3	245	293	1800	2200	6044M	18.8
300	419.5	56	3	265	370	1400	1700	61960X1	20.6
	420	56	4	265	370	1300	1600	61960M	20.7
	459.5	74	4	289	400	1200	1500	6060X1	45.5
	460	50	4	260	370	1200	1500	16060M	33.1
	460	74	4	289	400	1200	1500	6060M	48.4
	380	38	2.1	170	228	1100	1700	61860M	10.6
320	400	38	2.1	172	292	1300	1600	61864M	10.5
	480	74	4	356	510	1100	1400	6064M	50.3
	412	38	2.5	180	292	1300	1600	864	12.7
	440	56	3	278	395	1300	1600	61964M	24.9
340	420	38	2.1	160	260	1200	1500	61868M	12.5
	460	56	3	282	420	1100	1400	61968M	27
	520	82	5	403	620	1000	1300	6068M	63.4
360	440	38	2.1	173	242	1100	1400	61872M	12.2

深沟球轴承

Deep groove ball bearing

带止动槽 With snap ring groove

带止动环 With snap ring

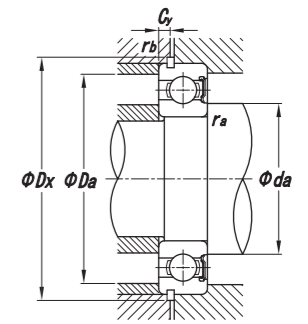
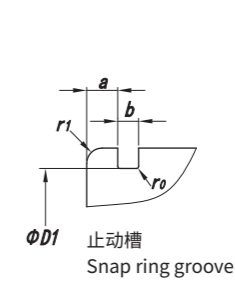
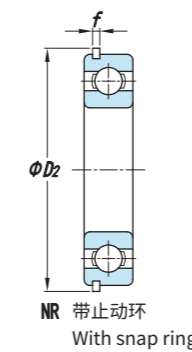
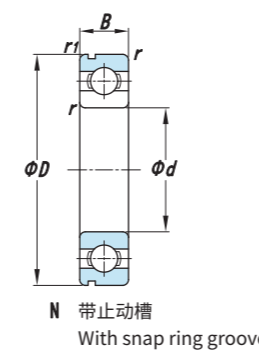

基本尺寸 Principal Dimensions (mm)				基本额定负荷 Basic Load Ratings (kN)		极限转速 Limit Speed (r/min)		现代号 New code	重量 Mass (kg)
d	D	B	r _{min}	C _r	C _{or}	Grease	Oil		
360	540	82	5	443	705	1000	1300	6072M	64.7
	480	56	3	282	400	1100	1400	61972M	28.2
380	480	46	2.1	232	375	1000	1300	61876	19
	520	65	4	335	550	1000	1300	61976M	39.8
	520	44	4	266	365	1000	1300	16976M	30
	520	65	4	335	550	1000	1300	61976M	39.8
	560	82	5	420	720	950	1200	6076M	78.2
400	500	46	2.1	225	365	1000	1300	61880M	20.75
	540	65	4	350	582	950	1200	61980M	39.4
	600	90	5	500	830	900	1100	6080M	86.5
420	620	90	5	490	850	900	1100	6084M	91.5
	560	65	4	320	520	900	1100	61984	41.9
440	540	46	2	240	445	900	1100	61888M	22.8
	600	74	4	380	648	900	1100	61988	60.5
	650	94	6	525	880	850	1000	6088M	108
460	580	56	3	304	430	900	1100	61892M	37.7
	620	74	4	405	678	850	1000	61992	63
500	620	56	6	325	607	750	900	618/500M	40
	660	75	5	395	716	750	900	619/500X3	68.8
	670	78	5	445	860	700	900	619/500M	75.5
	720	100	6	575	1020	750	900	60/500M	135
560	820	115	6	600	1500	630	750	60/560M	208

深沟球轴承

Deep groove ball bearing

带止动槽 With snap ring groove

带止动环 With snap ring

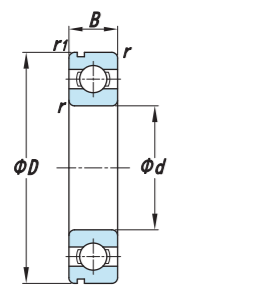

N 带止动槽
With snap ring groove

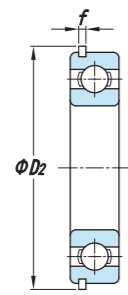

NR 带止动环
With snap ring

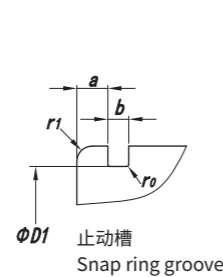

止动槽
Snap ring groove

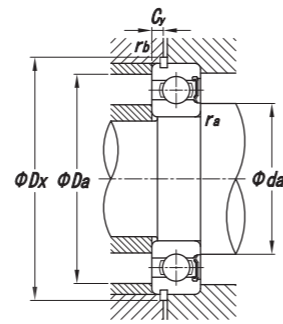

基本尺寸 Principal Dimensions (mm)				基本额定负荷 Basic Load Ratings (kN)		极限转速 Limit Speed (r/min)		现代号 New code	重量 Mass (kg)
d	D	B	r _{min}	C _r	C _{or}	Grease	Oil		
560	680	56	2.1	331	667	670	850	618/560M	43.5
630	850	100	6	590	1260	560	700	619/630M	164
670	820	69	4	445	960	530	670	618/670	83
710	1030	140	7.5	935	2180	450	560	60/710M	416.3
	870	74	4	456	1056	500	630	618/710M	98.5
750	920	78	5	650	1580	480	600	618/750M	112
800	980	82	4	559	1370	430	530	618/800M	135
	1150	115	7.5	950	2080	500	550	160/800X2	427
850	1030	82	5	545	1303	450	530	618/850M	144163.2
900	1090	85	5	600	1540	340	430	618/900M	168
950	1150	90	7.5	611	1620	300	380	618/950M	201
1000	1220	100	6	680	1720	300	380	618/1000M	230
1060	1280	100	6	730	2140	300	380	618/1060M	245
1180	1420	106	6	920	2580	320	360	618/1180M	310
1240	1480	112	6	930	2660	300	340	618/1240X1M	356

圆柱滚子轴承

Cylindrical Roller Bearing

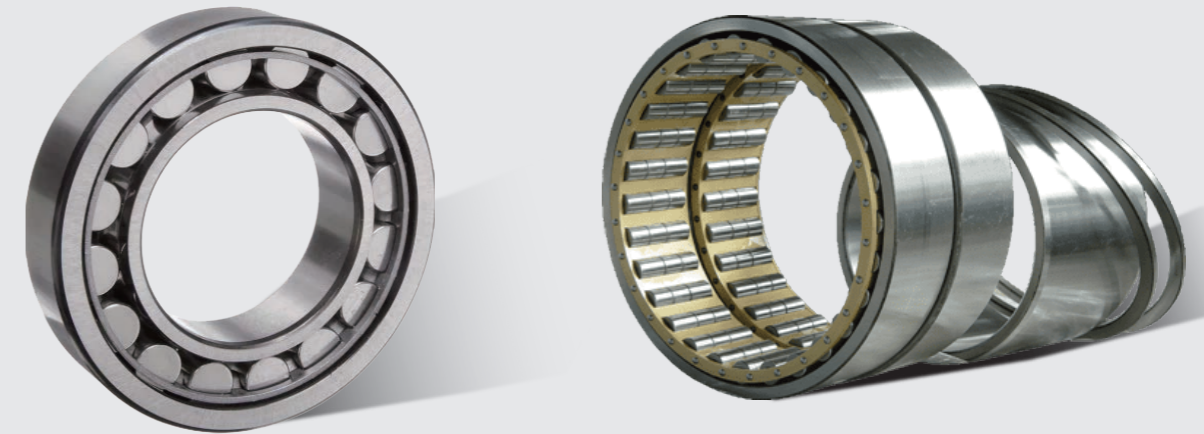

圆柱滚子轴承具有出色的径向承载能力,能够在高速运转下保持稳定。这类轴承设计使滚子与滚道之间接触面积增大,从而分散负荷并降低应力集中。这使它们特别适用于工业设备中的大功率电机、压缩机和传动装置等需要承受重载荷和高速运转的应用场合。

Cylindrical roller bearings have excellent radial load-bearing capacity and can maintain stability at high speeds. The design of these bearings increases the contact area between the rollers and the raceways, thereby distributing the load and reducing stress concentration. This makes them particularly suitable for heavy-duty and high-speed applications in industrial equipment, such as high-power motors, compressors, and transmission systems.